

Year - 2020

Vol. 7, No. 3

(ISSN 2395 - 468X)

Issue: March 2020

Van Sangyan

A monthly open access e-magazine



Indexed in:



COSMOS
Foundation
(Germany)



International
Inst. of Org. Res.
(Australia)



Tropical Forest Research Institute
(Indian Council of Forestry Research and Education)
Ministry of Environment, Forests and Climate Change (MoEFCC)
PO RFRC, Mandla Road, Jabalpur – 482021, India

Van Sangyan**Editorial Board**

Patron:	Dr. G. Rajeshwar Rao, ARS
Vice Patron:	C. Behera, IFS
Chief Editor:	Dr. Pawan Rana
Editor & Coordinator:	Dr. Naseer Mohammad
Assistant Editor:	Dr. Rajesh Kumar Mishra

Note to Authors:

We welcome the readers of Van Sangyan to write to us about their views and issues in forestry. Those who wish to share their knowledge and experiences can send them:

by e-mail to vansangyan_tfri@icfre.org

or, through post to

The Editor, Van Sangyan,
Tropical Forest Research Institute,
PO-RFRC, Mandla Road,
Jabalpur (M.P.) - 482021.

The articles can be in English, Hindi, Marathi, Chhattisgarhi and Oriya, and should contain the writers name, designation and full postal address, including e-mail id and contact number. TFRI, Jabalpur houses experts from all fields of forestry who would be happy to answer reader's queries on various scientific issues. Your queries may be sent to The Editor, and the expert's reply to the same will be published in the next issue of Van Sangyan.

Cover Photo: Panoramic view of Achanakmar-Amarkantak Biosphere Reserve

Photo credit: Dr. N. Roychoudhury and Dr. Rajesh Kumar Mishra, TFRI, Jabalpur (M.P.)

From the Editor's desk



Nurseries that work to strengthen and expand the presence of tropical native species are concerned about fostering diverse, strong, and well-adapted populations. For many tropical plants, however, the natural diversity of wild populations has been depleted. Habitat loss has reduced the range and sheer numbers of plants. For plants with commercial value, unsustainable harvesting practices may have reduced the numbers of plants with desirable characteristics while leaving behind inferior plants. The process of depleting a population of the best genetic properties so that future populations are weaker than the original populations is called genetic degradation.

Seed collection for plant propagation is an opportunity to reverse trends of genetic degradation and species loss. Nurseries have a key role in conserving the gene pool of native plants. Seed collection began as an art during the stone age. Later, it became a science when the need for improved seeds arose. The aim of seed collection is to obtain large quantities of seed of the best genetic quality. To minimize seedling variation, seeds should be collected from suitable sources.

Before creating a strategy for collecting native plant seeds, it is important to understand some key points regarding genetics and collection ethics. Seed collection strategies must protect genetic diversity for the future both at the collection sites and in the places where the offspring will be planted. On the outplanting sites, good seed collection practices ensure that inbreeding will not become a problem and that plant populations will be genetically viable to survive and adapt to new stresses. For restoration and conservation projects, maintaining genetic diversity is a key part of project objectives and of the target plant requirements

*In line with the above this issue of Van Sangyan contains an article on Seed collection, processing and nursery techniques for *Haldina cardifolia* – An important timber species in Central India. There also useful articles viz., DNA Profiling in Timber Forensics, Inhabitants of Achanakmar-Amarkantak biosphere reserve, Social and technological transformation vis-à-vis sustainability and Effects of earthquakes on environment*

I hope that readers would find maximum information in this issue relevant and valuable to the sustainable management of forests. Van Sangyan welcomes articles, views and queries on various such issues in the field of forest science.

Looking forward to meet you all through forthcoming issues

Dr. Pawan Rana
Scientist 'E' & Chief Editor

Disclaimer – Van Sangyan

Statement of Responsibility

Neither *Van Sangyan* (VS) nor its editors, publishers, owners or anyone else involved in creating, producing or delivering *Van Sangyan* (VS) or the materials contained therein, assumes any liability or responsibility for the accuracy, completeness, or usefulness of any information provided in *Van Sangyan* (VS), nor shall they be liable for any direct, indirect, incidental, special, consequential or punitive damages arising out of the use of *Van Sangyan* (VS) or its contents. While the advice and information in this e-magazine are believed to be true and accurate on the date of its publication, neither the editors, publisher, owners nor the authors can accept any legal responsibility for any errors or omissions that may be made or for the results obtained from the use of such material. The editors, publisher or owners, make no warranty, express or implied, with respect to the material contained herein.

Opinions, discussions, views and recommendations are solely those of the authors and not of *Van Sangyan* (VS) or its publishers. *Van Sangyan* and its editors, publishers or owners make no representations or warranties with respect to the information offered or provided within or through the *Van Sangyan*. *Van Sangyan* and its publishers will not be liable for any direct, indirect, consequential, special, exemplary, or other damages arising there from.

Van Sangyan (VS) reserves the right, at its sole discretion, to change the terms and conditions from time to time and your access of *Van Sangyan* (VS) or its website will be deemed to be your acceptance of an agreement to any changed terms and conditions.

	Contents	Page
1.	Seed collection, processing and nursery techniques for <i>Haldina cardifolia</i> – An important timber species in Central India - S. Saravanan, M. Kundu and N. Berry	1
2.	DNA Profiling in Timber Forensics - Tresa Hamalton	5
3.	Inhabitants of Achanakmar-Amarkantak biosphere reserve - N. Roychoudhury, Ruby Sharma and Rajesh Kumar Mishra	10
4.	Social and technological transformation vis-à-vis sustainability - Nahid Khan	16
5.	Effects of earthquakes on environment - Rekha Agarwal	22

Seed collection, processing and nursery techniques for *Haldina cardifolia* – An important timber species in Central India

S. Saravanan, M. Kundu and N. Berry

Silviculture, Forest Management and Agroforestry division

Tropical Forest Research Institute

(Indian Council of Forestry Research & Education, Ministry of Environment, Forests and Climate Change, Govt. of India)

RFRC (PO), Mandla Road

Jabalpur – 482021. Madhya Pradesh, India

About the species

Haldina cardifolia Roxb. commonly known as 'Haldu' and 'Karma' is a large deciduous tree, up to 40 m tall by 2.2 m in diameter. Leaves opposite, heart shaped, 10-22 cm long. Flowers yellow, in round heads up to 2.5 cm in diameter, on long stalks. Fruits are numerous, in round heads. An important timber tree in the Terai, so far only planted on a small scale (Iqbal et al. 2009).

Haldu is a light-demanding species, growing best on freely drained soil, for instance on lower slopes of hills among boulders. It grows on a wide range of soils, and will tolerate soils with high pH values, up to 8.3. It is susceptible to frost damage and to fires. The long, straight, clean bole can be up to 150 cm in diameter and is often buttressed and fluted at the base. The buttresses are sometimes of irregular and fantastic shapes. When growing in more isolated positions it produces a thick bole and massive branches with a large spreading crown (Tntreepedia, 2018).

The heartwood is yellow to yellow-white when fresh, turning pale-yellow or reddish-brown when exposed; it can be clearly or not clearly demarcated from the very wide band of yellow-white sapwood. The texture is fine and even; the grain fairly straight, though occasionally interlocked or spiralled; the surface is lustrous (Kulkarni et al. 2015).

The wood is moderately heavy, moderately hard and moderately durable with some resistance to fungal attack. It seasons normally, with only a slight risk of distortion, but a high risk of checking; once dry it is moderately stable in service. It is easy to work by hand and with machine tools, though it should be planted with care to avoid picking single fibres up; it polishes well and takes a high lustrous finish; nailing and screwing are good; gluing is correct (Troup, 1921).

The wood is valued for making small items such as combs and for turnery, it is also used for construction, window frames, furniture, bobbins, boxes, piano keys, rulers etc. The wood is reported to be acid-resistant, making it suitable for use as laboratory bench tops etc.

Flowers are yellow in colour and appear from June to August. Fruits ripen from February to May when the heads turn yellowish black when they are ripe.

Capsules in globose heads of 200 to 300, each splitting in to 2 dehiscent cocci. Seeds are extremely minute and one kilogram of seed contains approximately 1,10,00,000 to 1,18,00,000 seeds.

Seed collection and storage

The heads are plucked in February to March from the branches and dried in the sun to break and then immersed in the water to separate the fertile seeds which settle down. The fertile seeds are dried in the sun and the cleaned by winnowing

which can be stored in the sealed tins up to second season. Seeds germinate better after storage because they require after ripening (Jeena et al. 2012).

The seed is shed between April and June, and is often carried fairly long distances by the wind. It germinates early in the rains, and to establish itself successfully the seed must fall on bare ground, such as landslips, alluvial soil near rivers, and abandoned cultivation. The young seedlings are very small and liable to be washed away or beaten down by rain.

Normally *Haldina* will be propagated by seed. Pre-treatments are not required and treatment with hot water will help to give uniform and quick germination. Fresh seed gives 30-40% of germination. The seed is very small and so should only just be covered with soil before sowing in the mother bed. The seed is best sown in a seed-box that is placed in light shade and protected from heavy rain otherwise there is a chance for washing away due to rain (Nair et al. 2004).

Watering to the mother bed is required frequently but with a very fine spray. Normally germination takes place in 20 - 40 days. As soon as the seedlings are large enough to handle, that is, in about two to three months, they should be pricked out and will be planted in to poly bags for out planting. The more vigorous ones may even be pricked out about 10 cm apart in nursery-beds.

A layer of brushwood is spread over the beds and burnt to produce the ash over which the seeds are broadcasted in April to May and covered with a fine layer of soil. Shading of beds is necessary. Two months old seedlings are transplanted. Weeding is avoided for some weeks after germination. Seedlings are fit for planting during the

next year. ITs growth is very slow in the first year.

The seedlings will be ready to plant out for various forestry programmes early the following rains. Transplanting is not unattended with risk owing to the liability of the seedlings to die of drought care is therefore necessary to keep a ball of earth round the roots. Risk is further avoided by pricking out the plants into baskets or bamboo tubes instead of into boxes or nursery beds, so that there is no interference with the roots during transplanting.

Growth in the first year is very slow, and the seedlings often reach only 2.5 cm in height during this time; in the second year growth is faster, and the seedlings develop thick taproots. 3. The young seedlings appear to benefit from shade, but if this continues growth remains stunted until the canopy is opened to admit more light.

Young seedlings grow very slowly in their first year, reaching a height of only 25 – 150 mm and are very susceptible to being washed away or beaten down with rain at this time. Growth is faster in the second year, with plants reaching heights of 30 – 60 cm or more. Plants develop a thin but long tap root in their first year. This thickens and develops considerably in the second year. The seed can be stored for at least 12 months (Kundu, 2018).

Plantation technique

One year old seedlings are preferred for planting in the main field and other forestry plantation programmes. One and above seedlings are generally planted in the pit size of 30cm³. The most common spacing adopted for plantation is 3x3 m. For avenue plantations, bigger size pits are preferable for faster growth and establishment.

When seedlings are planted too deep in the soil, they may die of crown rot. Seedlings also subject to attacked by powdery mildew and root rots. To control, spraying of antibiotic fire blight materials is very much required during bloom period. Proper removal of diseased seedlings/branches will control further spread of diseases to healthier seedlings in the nursery.

For proper growth and survival, it is necessary to give one or two watering after planting. This is specifically required in arid regions. Irrigation after planting is not a prerequisite in areas having sufficient soil moisture and rainfall. Higher survival rate and better rate of growth is reported when soil and water conservation measures are also adopted (Nair et al. 2004).

References

- Iqbal, P.F., Bhat, A.R. and Azam, A. 2009. Antiamoebic coumarins from the root bark of *Adina cordifolia* and their new thiosemicarbazone derivatives. *European Journal of Medicinal Chemistry*, 44 (5): 2252-2259.
- Jeena, L.S., Kaushal, R., Dhakate, P. M. and Tewari, S.K. 2012. Seed maturation indices for better regeneration and multiplication of Haldu (*Adina cordifolia*). *Indian Journal of Agricultural Sciences*, 82 (4): 381-383.
- Kulkarni, S.S., Hegde, G.R. and Bhat, P. 2015. A field key to the deciduous trees of Anshi national park. *Indian Forester*, 141(3): 298-307.
- Kundu, M. 2018. *Haldina cordifolia* (Roxb.) Ridsdale. Disponible en [https://ign.ku.dk/english/employees/forest-nature-biomass/?pure=en%2Fpublications%2Fhal-dina-cordifolia-roxb-ridsdale\(ba46f7b9-1eac-4d3a-aa3ed18ac222d4c0\).html](https://ign.ku.dk/english/employees/forest-nature-biomass/?pure=en%2Fpublications%2Fhal-dina-cordifolia-roxb-ridsdale(ba46f7b9-1eac-4d3a-aa3ed18ac222d4c0).html)
- Nair, K.K.N., Mohanan, C and Mathew, G. 2004. *Plantation Technology of Haldina cordifolia* (Manjakadambu). Kerala Forest Research Institute pp.1-7.
- Tamil Nadu Tree Pedia. 2018. Disponible en <https://www.tntreepedia.com/treedetails/?id=fcab36e04f0d1596be2bc84fd6d5db24>.
- Troup, R.S. 1921. *The Silviculture of Indian Trees*. Volume II. International Book Distributors, Dehra Dun, pp. 616-621.

Haldina cardifolia



Mature tree



seedling stage



Budding stage



Flowers



Bark



Plant

DNA profiling in timber forensics

Tresa Hamalton

Silviculture and Forest Management Division,
Institute of Wood Science and Technology

(Indian Council of Forestry Research & Education, Ministry of Environment, Forests and Climate Change, Govt. of India)
Bangalore-560003.

Various techniques, using visual, chemical and genetic approaches, are available for ascertaining the source of timber material. For degraded and/or contaminated samples lacking physical features, genetic approaches are most reliable, because neither degradation nor contamination can alter the genetic material of the sample. Genetic analyses can address many questions pertaining to forensic timber identification by determining the taxonomic (family / genus / species), geographic (provenance), and individual sources of timber material. Among the genetic approaches available for use in timber forensics, karyotyping and phylogenetic analysis were described earlier, and DNA profiling techniques are explained herein.

Polymerase chain reaction (PCR) is a molecular biology tool used for making many copies of a specific region in a DNA sample. It involves the use of primers which are short nucleotide sequences that can bind to complementary (opposite) regions in the template (sample) DNA and amplify (multiply) the target region.

DNA profiling is based on the principle that, wherever a PCR primer has sequence complementarity with the DNA sample in question, it will bind and a PCR product will be formed. As a result, PCR products of variable size are produced which form a unique DNA profile/fingerprint during gel electrophoresis. Thus, they are DNA fragment markers and can be used for

discriminating individuals at the population or individual level, as well as differentiate between wild and cultivated trees. The different DNA profiling techniques used in forensics are described.

Graphical representation of DNA amplification by PCR

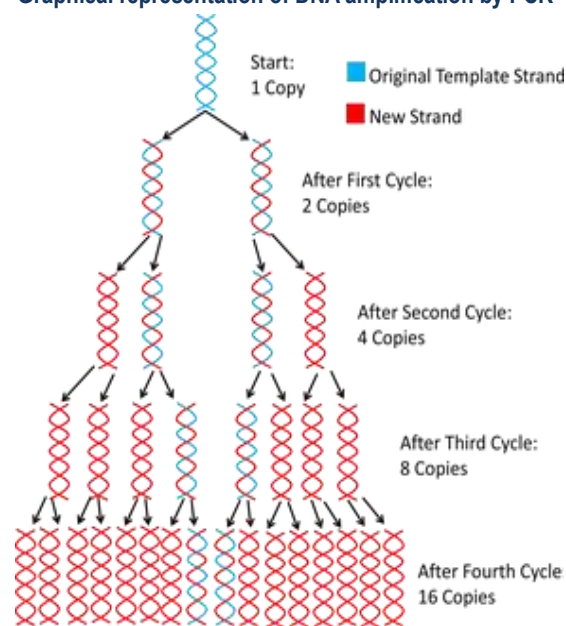

Restriction Fragment Length Polymorphism (RFLP)

RFLP was the first DNA fingerprinting technique developed, and is not PCR based. Instead it makes use of restriction enzymes, which recognise and cut the DNA sample at specific regions called restriction sites, to produce small DNA fragments of varied size. The number and size of the resulting fragments depends on the location and number of restriction sites available in the sample DNA. These restriction fragments can then be separated by gel electrophoresis, during which a DNA profile is generated.

Though this technique was earlier used frequently for sample identification, lineage determination and genetic diversity characterisation, it is not PCR based, requiring more quantity of DNA sample for analysis. Moreover, the possibility of a random match between unrelated DNA samples, when using RFLP analysis, is higher compared to later developed techniques. Hence, it was replaced by more sensitive PCR based techniques, which require comparatively lesser quantity of DNA and are more discriminating.

Random Amplified Polymorphic DNA (RAPD)

RAPD is a type of PCR in which the DNA segments amplified are random. When no prior knowledge of the sample DNA sequence is available, short (8–12 nucleotides), arbitrary primers are used. These random primers bind to available complementary regions in the sample DNA and amplify them.

Differentiating 2 DNA samples using RAPD

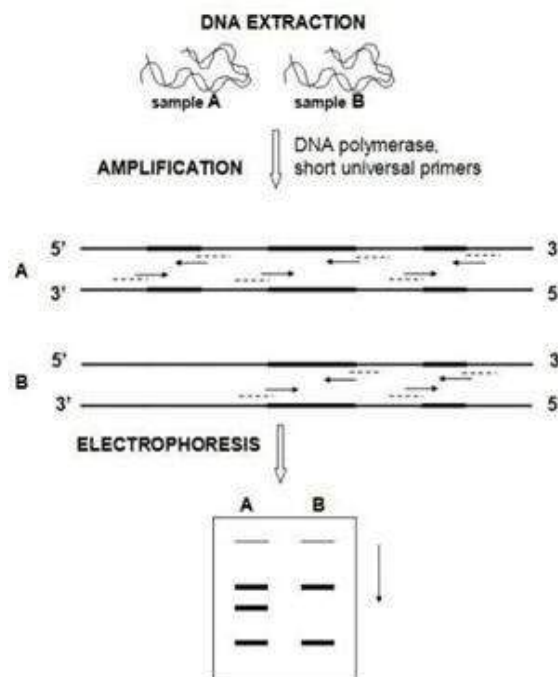
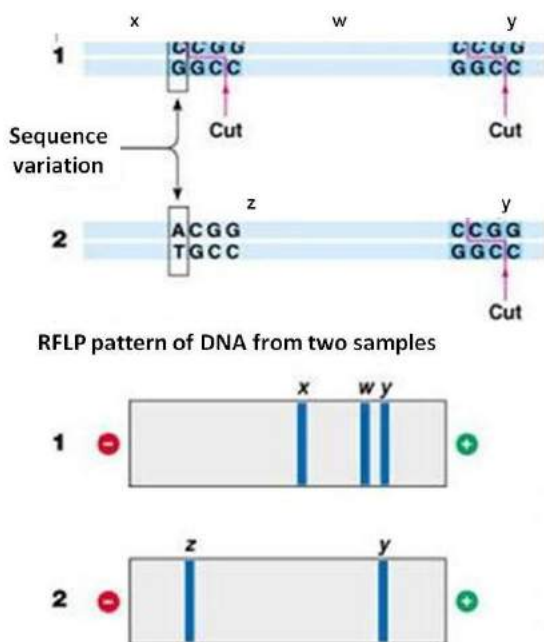

The no. of PCR products obtained by this method will depend on the no. of primer binding sites in the DNA sample. The size of these PCR products will also vary, producing a DNA profile during gel electrophoresis. The DNA profile obtained for each sample DNA will be unique due to differences in DNA sequence, and this is used to differentiate between individuals. RAPD is the most commonly used DNA fingerprinting technique.

PCR-RFLP

PCR-RFLP is a technique involving PCR amplification of a targeted region in the sample DNA, followed by fragmenting of that region using restriction enzymes. In this method, the sequence variation within the amplified region alone is used, and is also termed as Cleaved Amplified Polymorphic Sequence. Though lesser DNA sample is sufficient for analysis by PCR-RFLP, it requires prior knowledge of sequence information unlike RFLP or RAPD. Hence it is not commonly used for forensic analysis.

Amplified Fragment Length Polymorphism (AFLP)

AFLP is another PCR based DNA fingerprinting technique, which uses restriction enzymes also. The DNA sample is first fragmented using restriction enzymes, and small adaptors or linkers are joined to the restriction fragments. The adaptors, which are short DNA molecules, serve as known sequence for primer, and these fragments are amplified using PCR. The fragments are subject to two subsequent PCR amplifications: preamplification and selective amplification, using primers with 1 or 3 extra nucleotides respectively, resulting in high selectivity. The resulting DNA fragments then produce a fingerprint during gel electrophoresis, which will vary for different samples. Though the level of discrimination and reliability are high using AFLP, it also requires more quantity of good quality DNA just like RFLP, compared to other PCR based profiling techniques, and is also cumbersome.

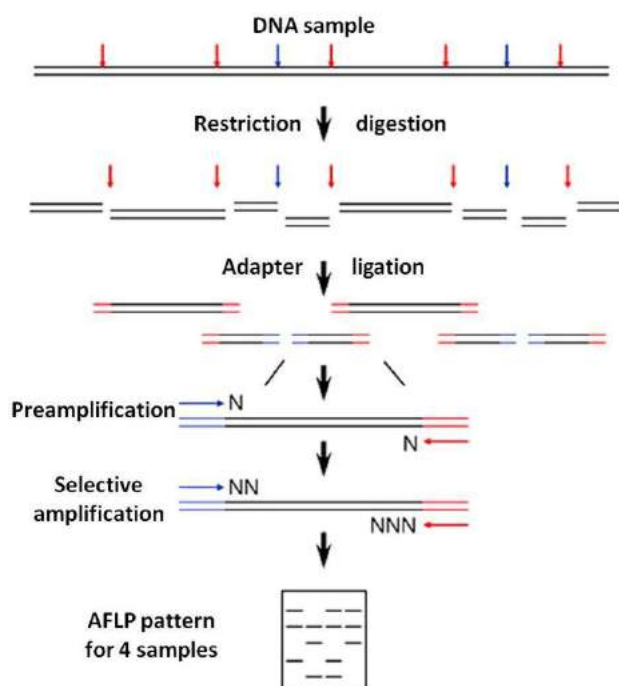

Microsatellite markers

Microsatellites or Single Sequence Repeats (SSR) are short DNA fragments in which one to six bases are repeated many times.

Such sequences occur naturally in the DNA of all plants, at thousands of locations. The regions at the ends of an SSR are unique, and primers complementary to these unique regions are used for PCR amplification of the DNA sample. The size of the fragments obtained through PCR will differ based on the number of repeats at the amplified region for each individual sample. The fragments, thus, create a DNA fingerprint during gel electrophoresis.

The development of the right primers is a tedious and expensive process in SSR analysis, and DNA sequence information should be known previously. SSRs are used widely for studying genetic diversity of populations, to locate trait-related genes based on genetic linkage, and in forensic identification. In the forensic science jargon, this DNA profiling technique is most commonly referred to as Short Tandem Repeat (STR) analysis.

SSR profile of different genotypes with varied no. of repeats

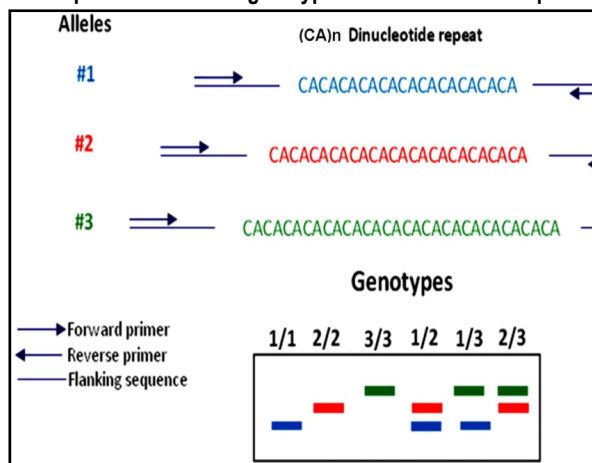

Inter-Simple Sequence Repeat (ISSR)

ISSR is the region between two microsatellites in a DNA sample. Sequences complementary to the two microsatellites are used as primers during PCR, resulting in amplification of the variable (ISSR) region between them. The PCR products thus obtained will be a mix of DNA fragments that vary in length,

creating a DNA profile during gel electrophoresis.

Though it is a widely used DNA fingerprinting technique for studying genetic diversity of different populations, it cannot be used for discriminating between individuals, and is not much preferred in forensic analysis. However, determining the sequence of ISSRs can be useful in designing primers for SSR analysis.

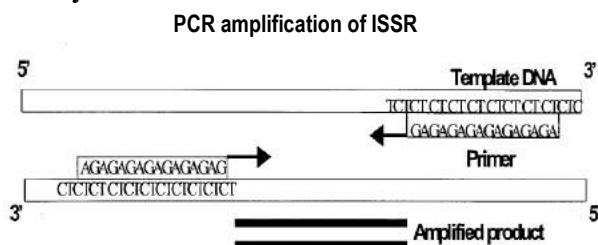

Conclusion

Genetic approaches are the most reliable for determining the taxonomic, geographic and individual source of timber material, as DNA information cannot be altered and remains the same throughout the sample. Minute quantities of the wood sample in question, which may be physically degraded or contaminated, can be identified using genetic tools, making them superior to other screening methods available. However, if the quantity of DNA extracted from the sample is very less or degraded, variations may arise in the DNA profile of the same individual while using PCR based methods.

Many DNA marker techniques are available for determining DNA polymorphism, in addition to those mentioned herein. But those techniques are not used for forensic timber identification. Every genetic tool can answer only specific questions in timber forensics, and the choice of the technique to be used is decided based on the questions that need to be addressed. Regarding the advantages

and disadvantages of all the DNA profiling techniques, RAPD is the most preferred and widely used technique in timber forensics.

DNA profiling is the most commonly used genetic approach to answer the questions ‘from which individual?’, and ‘from which provenance?’ because it can differentiate populations and/or individuals. However, it cannot be used to ascertain the taxonomic identity of the sample; DNA sequence markers are most preferred in this case, and will be illustrated later.

References

- Coyle H.M., Palmbach, T., Juliano N., Ladd C. and Lee H. C. (2003) An Overview of DNA Methods for the Identification and Individualization of Marijuana. *Croatian Medical Journal*, 44: 315-321.
- Dormontt E. *et al.* (2015) Forensic timber identification: It's time to integrate disciplines to combat illegal logging. *Biological Conservation*, 191: 790-798.
- Finkeldey R., Leinemann L. and Gailing O. (2010) Molecular genetic tools to infer the origin of forest plants and wood. *Appl Microbiol Biotechnology*, 85:1251–58.
- Hamalton T. (2016) DNA from ancient wood. *Van Sangyan*, 3(10): 27-30.
- Hamalton T. (2016) Wood DNA. *Van Sangyan*, 3(9): 10-13.
- Hamalton T. (2017) Timber forensics. *Van Sangyan*, 4(10): 11-13.
- Hamalton T. (2018) Genetic tools for timber forensics. *Van Sangyan*, 5(2): 17-20.
- Semagn K., Bjørnstad Å. and Ndjiondjop M.N. (2006) An overview of molecular marker methods for plants. *African Journal of Biotechnology*, 5(25): 2540-2568.

Tnah L.H., Lee S.L., Siong Ng K.K.,
Bhassu S. and Othman R.Y. (2012)
DNA extraction from dry wood of
Neobalanocarpus heimii

(Dipterocarpaceae) for forensic
DNA profiling and timber tracking.
Wood Science and Technology,
46(5): 813-82.

Inhabitants of Achanakmar-Amarkantak biosphere reserve

N. Roychoudhury, Ruby Sharma and Rajesh Kumar Mishra

Tropical Forest Research Institute

(Indian Council of Forestry Research & Education, Ministry of Environment, Forests and Climate Change, Govt. of India)

Jabalpur -482 021, Madhya Pradesh

E-mail : choudhury_nr@yahoo.com, ruby_x_sharma@yahoo.co.in, mishrark@icfre.org

Abstract

Information on population of different villages of Achanakmar-Amarkantak biosphere reserve collected from different sources revealed that there are 418 villages with a total population of 4, 36, 128 in core, buffer and transition zones. There are 27 communities living in different zones. The inhabitants are poor and depend mainly on agriculture and partially on biosphere reserve for fuel, fodder, food, medicine, etc.

Key words: Achanakmar-Amarkantak biosphere reserve, inhabitants, core, buffer, transition zone.

Introduction

Achanakmar-Amarkantak Biosphere Reserve is the first biosphere reserve of Chhattisgarh State and 14th biosphere reserve of the country, declared by Government of India during the year 2005, vide No. 9/16/99 CS/BR dated 30th March 2005 (Anon, 2007a) (Fig.1). It lies between latitude 22^o 15' to 20^o 58' N and longitude 81^o 25' to 82^o 5'E and is spread from Maikal hill ranges to the junction of Vindhyan and Satpura hill ranges in a triangular shape. Achanakmar-Amarkantak biosphere reserve is the most dramatic, ecologically diverse, least developed and least disturbed area falls under Deccan Peninsula biogeographic zone of tropical dry and moist deciduous forests biome of India and spread over in Chhattisgarh and Madhya Pradesh with topography ranging

from high mountains, shallow valleys and plains (UNESCO-MAB, 2012, <http://www.unesco.org/mab>).

The biosphere reserve supports three major river systems of central Indian region, viz. Narmada, Sone and Johilla and their tributaries. Its boundaries start from Kota and Lormi forest ranges of Bilaspur district in (Chhattisgarh) south to Rajendragram forest range of Anuppur district (Madhya Pradesh) in the north and Belgahana forest range of Chhattisgarh in the east to Dindori forest range of Dindori district in Madhya Pradesh. The total geographical area of biosphere reserve is 38, 35.51 sq. km (Anon, 2007a,b). It consists of three distinct zones, viz. core zone with an area of 551.55 sq. ha. in Chhattisgarh state, buffer zone with an area of 1,95,587.5 sq. ha. in Madhya Pradesh and Chhattisgarh, and outer most transition zone with an area of 132808.5 sq. ha. in both the states.

The biosphere reserve has three distinct seasons, viz. monsoon, which begins from July and continues up to October, winter from November to February and summer from March to June (Anon, 2008). The lowest temperature in winter is -2^o C, which rises up to a maximum of 46^o C in June and the humidity varies from 39 % to 90%. The annual rainfall is about 1624 mm. The forest vegetation is tropical deciduous type and is classified into "Northern Tropical Moist Deciduous and

Southern Dry Mixed Deciduous forests (Fig. 2) (Champion and Seth, 1968). The drainage system of biosphere reserve consists of rivers originating from the core and buffer zones and a water check dam known as Khudia dam built on the Maniari river towards south-west of the biosphere reserve, fulfills the water needs of inhabitants and wildlife. As a whole, Achanakmar-Amarkantak biosphere reserve is a paradise of nature (Roychoudhury et al., 2012).

Inhabitants and their socio-economic profile

Nearly 7,617 traditional primitive tribal inhabitants, as per the population census of the year 2001, are settled in 22 villages of the core zone (Anon, 2010). The buffer and transition zones of biosphere reserve comprises of 399 villages and sub urban areas with a population of 4,40,404 persons. Recent information on population of different villages of biosphere reserve collected from different sources revealed that there are 418 villages with a total population of 4,36,128 in biosphere reserve (Table 1). Six villages with a total population of 1,177 of core zone of biosphere reserve namely Bankul, Bokrakachar, Sambhardhasan, Bahawal, Jalda and Kuba were shifted to other locations in buffer zone (Roychoudhury, 2013). Major residential areas or settlements namely Kota, Khondri, Dindori, Amarkantak, Pendra road, Karanjiya, Gorakhpur, Lormi, Akhrar, Rajendragram and some revenue and forest villages like Jagatpur, Kabir, Rajki, Boirha and Sarasdol exist in buffer and transition zones (Fig. 3). There are 27 communities living in different zones in the biosphere reserve. These are Baiga, Gond, Dhanwar, Kol, Kanwar, oraon, Chamar, Sais (Sarathi), Basore, Lonia,

Muslim, Sindhi, Brahmin, Rajput, Goswami, Baraith, Kalar, Kumhar, Kewat, Nai, Ahir (Raut), Panika, Sondhiya, Lohar, Maratha, Sonar and Baniya (Anon, 2012).

The major tribes residing in biosphere reserve are Baiga, Gond, Kol, Kanwar, Pradhan and Panka (Joshi and Sharma, 2012). The baigas are primitive Dravidian tribe. They are the most ancient, remarkable and delightful oldest tribe of India. They migrated from eastern Satpura hills and settled in Bilaspur district of the biosphere reserve. They use to avoid tilling and ploughing due to their rituals and beliefs. Presently, the baigas are dominant in population and ranked on the top among the other tribal communities in the biosphere reserve. They are settled in maximum numbers at Mahamai followed by Chhapparwa, Jalda, Lamni, Rajak and Surhi (Fig. 4). They get fuel, fodder, edible roots and tubers from forest besides cultivating some seasonal agricultural crops in small areas. Mahamai village has two hamlets namely Babutola and Ghameri where 13 and 45 families are living from last 10 to 15 years. Baiga is an endogamous group. The population of baiga is increasing due to the high birth rate and immigration from other parts of the state. Now, some of them have come forward and changed their primitive lifestyle. Gonds also have their origin from Dravid culture. Gond of core area is known by Pathare Gond and Singraulia Gond based on their place of migration. Their economy is largely dependent on agricultural labour. Kols migrated to Madhya Pradesh and Chhattisgarh from Singhbhum district of Jharkhand province. In the present biosphere reserve, they are settled at Achanakmar, Bindawal, Bamhani, Chhapparwa, Jakadbandha and Lamni. Kanwar refers to their origin to

Mahabharata times. They constitute two types of family i.e. single and joint family. Majority of them, live as single family. Oraons are also Dravidians tribe migrated from Chhota Nagpur. Some of them have come from Sarguja district and settled in biosphere reserve in early eighties. They are mobile traveler community with a tradition of ready acceptance of innovations. They are now settled in Surhi, Jakadbandha, Daganiya, Mahamai, (core zone) and Jamunahi, Ghameri and Babutola (transition zone). Besides this, traders have also migrated from nearby areas. They are now settled in some sub urban localities like Kota, Gorakhpur, Amarkantak.

All tribal and non-tribal inhabitant, get fuel, fodder, edible roots and tubers from forests of biosphere reserve, besides cultivating some seasonal agricultural crops like wheat, maize, etc. in small areas. The cattle are low milk producing, unproductive and dependent on forest for grazing. Some of the labourers are engaged by Forest Department. Besides this, lack of education, unapproachable roads and foot paths in remote areas are some of the main huddles in upliftment of the status of the inhabitants. Non-wood forest produce (NWFP) collection plays a vital role in the economy of the inhabitants.

Acknowledgements

Authors are thankful to Director, Tropical Forest Research Institute, Jabalpur-482021 (M.P.), for providing necessary research facilities to carry out work under the extramural research project, entitled "Lead Institution for Achanakmar-Amarkantak Biosphere Reserve, Chhattisgarh" (ID No. 148/TFRI/2010/Ento-2(MoEF) (23). Special thanks are due to Ministry of Environment, Forests and Climate Change,

New Delhi, Government of India, for assigning Lead Institution to Tropical Forest Research Institute, Jabalpur and providing financial assistance.

References

- Anonymous (2007a). Achanakmar-Amarkantak Biosphere Reserve. Compendium. Tropical Forest Research Institute, Jabalpur, 69 pp.
- Anonymous (2007b). Achanakmar-Amarkantak biosphere reserve. Biosphere Reserve Information Series (BRIS) 1 (1): 134 pp.
- Anonymous (2008). Achanakmar - Amarkantak biosphere reserve. Biosphere Reserve Information Series (BRIS) 1(2): 86 pp.
- Anonymous (2010). Achanakmar-Amarkantak biosphere reserve. Biosphere Reserve Information Series (BRIS) 2(1-2): 158 pp.
- Anonymous (2012). Achanakmar-Amarkantak Biosphere Reserve. Biosphere Reserve Information Series (BRIS) 3(1-2): 93 pp.
- Champion, H.G. and Seth, S.K. (1968). A revised survey of the forest types of India. Manager of Publications, Delhi.
- Joshi, K.C. (2009) Project completion report on Lead Institute Achanakmar-Amarkantak biosphere reserve (Phase-I). Submitted to Ministry of Environment, Forests and Climate Change, New Delhi, 150 pp.
- Joshi, K.C. and Sharma, R. (2012). Achanakamr-Amarkantak biosphere reserve-central highlands, India. In : Compendium on Indian Biosphere Reserves (Eds. Palni, L.M.S., Rawal, R.S., Rai, R.K. and Reddy, S.V.), pp. 152-160, Ministry of Environment,

Forests and Climate Change, Govt. of India.

Roychoudhury, N. (2013). Project completion report on Lead Institute Achanakmar-Amarkantak biosphere reserve (Phase-II). Submitted to Ministry of

Environment, Forests and Climate Change, New Delhi, 91 pp.

Roychoudhury, N., Sharma, R., Yadav, D. K. and Kushwaha, D. K. (2012). Achanakmar-Amarkantak biosphere reserve: a paradise of biodiversity. Vaniki Sandesh, 2(4): 27-37.



Fig.1. Map showing core, buffer and transition zones of Acanakmar-Amarkantak biosphere reserve



Core zone

Buffer zone

Fig.2. View of Acanakmar-Amarkantak biosphere reserve



Fig.3. Tribal village in buffer zone of Achanakmar Amarkantak biosphere.



Fig.4. Primitive Baiga and Gond tribe in Achanakmar-Amarkantak biosphere reserve

Table 1. Distribution of population in the core, buffer and transition zones of Achanakmar-Amarkantak biosphere reserve

Zone	State	District	Number of villages	Population
Core zone	Chhattisgarh	Bilaspur	22*	7617*
Buffer zone	Chhattisgarh	Bilaspur	55	79913
	Madhya Pradesh	Anuppur	25	22677
		Dindori	13	12121
Total buffer zone			93	114711
Transition zone	Chhattisgarh		170	210108
	Madhya Pradesh		49	32984
	Dindori		84	70708
Total transition zone			303	313800
Grand total of biosphere reserve			418	436128

*Six villages with a total population of 1177 shifted from core zone to buffer zone.

Social and technological transformation vis-à-vis sustainability

Nahid Khan

Department of FarmForestry, Sant Gahira Guru Vishwavidyalaya
Ambikapur, Surguja (C.G.), INDIA
Email: nahidkhan1618@gmail.com

Abstract

Science and technology has a reflective impact on all of humanity's activities. Science and technology are key drivers to development, because scientific and technological revolutions strengthen economic advances, improvements in health systems, education and infrastructure as well as sustainable development. India is continuously achieving the new progress in the field of science and technology as well as innovation and improving knowledge base. This provides innovative ideas to receive direct and indirect benefits of scientifically or technologically improved or modified product, process, newer organizational methods and techniques. Human has produced wide variety of discoveries in science and technology which led to the building and developing the civilizations of each age, raised people's standards of living, encouraged cultural development, and had a great impact on religion, thought, and many other human activities. In modern time science and technology are necessary ingredients in human life. Therefore, organizational, social and technological innovations are the key instruments of sustainability.

Keyword: Environment, Livelihood, Sustainable development, Science and Technology

Introduction

In the modern era of science and technology social transformation is taking

place in every sphere of human build environment. These transformations have revealed positive as well as negative consequences concerning the environment and development. These therefore call for harmonized approach between society, economic, environment as well as resources. Societal evolution and transformation also comprised technological evolution. The scientific and technological activity explains unknown phenomena, and to the formation of new knowledge through the invention of new natural laws and principles, and after obtaining new knowledge it is then utilized in the real society (World Bank, 2014). Science and technology contributes the creation of new knowledge to society, and then this knowledge is used to boost the prosperity of human lives, and to resolve the different issues facing society. Science can be considered to be the foundation strength of society. Science and technology has also transformed the various science including agriculture, forestry, soil water conservation, plant science and bioscience, social and technological aspects as well as allied fields. These have changed the production, conservation and management aspects of all natural resources. Technology has a key role here in supporting such strategies. These would encourage adoption of improved technologies, and increasing yield and resource conserving investments and thus leading to livelihood diversification (Jhariya *et al.*, 2019a, 2019b; Raj *et al.*, 2020; Banerjee *et al.*, 2020).

The sustainable design of socio-technological system is needed in present scenario towards resources conservation and management as well as human welfare (UNEP, 2015). Thus present title highlighted the social environment transformation under the umbrella of science and technology toward sustainability.

Social Empowerment, Science and Technology

Presently science, technology and innovations are the key pillar of social milieu and transformed the social environment and changed social imagery. This reflects the social adoption, social change perspectives, social empowerment and transformation. The empowerment idea initiated through developmental approaches addressing people needs. The empowerment mainly focuses on improvement of community lives in a

sustainable manner. In this context science and technology seems to be an empowering tools for social development. The social transformation means moving forwards with social environmental development and equitable distribution of economical, social, cultural and political powers (Figure 1). The social empowerment can be achieved through proper planning, developmental project, education, awareness, capacity building and need based training for betterment of their livelihood and standard of living (FAO, 2020). The people participation and mass awareness towards science and technology can be meet out through good governance and need based orientation of these community to develop the respect of natural resources and environment for sustainable development.

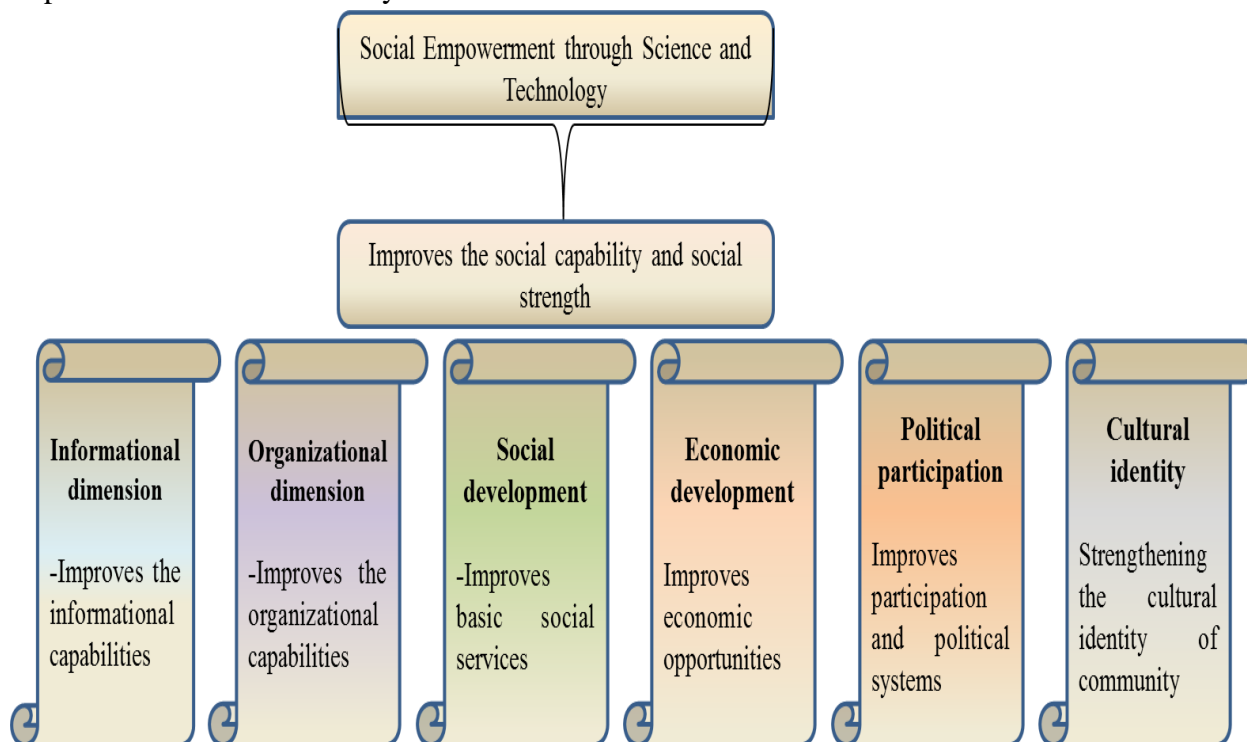

Figure 1: Social empowerment and transformation towards development

Sustainable Development

In the present context of climate change, population rise, global warming, resource

depletion, global competitiveness toward development it becomes priority to move with sustainable way. In this perspective the trinity of sustainability pillars i.e., social cohesion, long term dynamics efficiency, and environment needs to be balanced properly (Jhariya *et al.*, 2019a, 2019b). This leads to real welfare of peoples.

Further proper research and development activities should be taken into consideration for need based innovation which can fulfil the social needs as well as global agenda of sustainable development.

In this perspective, science and technology play key role for suitable innovation design which is ecological, environment and social friendly (**Figure 2**). Moreover, ideal policy and legal framework should be designed and implemented for strengthening the goal and challenge of sustainability and sustainable development. The sustainable development focusing on the following key criteria (Kongoli, 2016)-

1. Environmental protection
2. Economic development
3. Social development

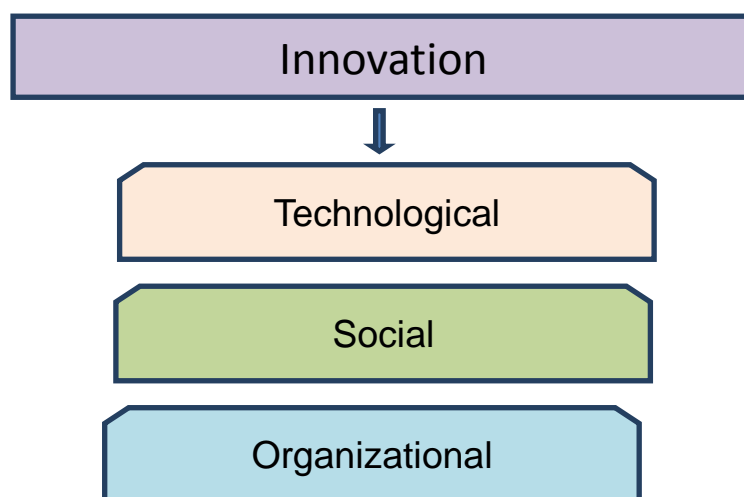

Figure 2: Types of innovation for sustainable development

Further the following instrument determine the sustainability and sustainable development to a great extent (Kongoli, 2016)-

1. Science, technology and innovation.
2. Good governance and management aspects.
3. Social education and awareness.

Innovation and Environmental Sustainability

In developing countries, unsustainable use of natural resources, increase in living standard of people, agricultural practices, changes in land use, changing climate, manufacturing and production technology, pollution, etc., degrade the environmental quality (Khan *et al.*, 2020a, 2020b). These also increase the negative externalities through resource depletion and harm to human health and lives (Raj *et al.*, 2020; Banerjee *et al.*, 2020).

In this context, time to time up-gradation of traditional knowledge and technology needs to be applied for dealing with environmental causing factors through innovation and technology for reduction of footprints on the natural environment (Ulucaket *et al.*, 2020). These should be cleaner, safer, resource conserving, eco-friendly having low environmental cost to move forward with sustainable manner. Hence, resources conserving and environmentally sound technology are the need of the hour in present context to find out the way for sustainable development. This offer the prospect and possibility and challenges for technological innovation for environmental sustainability (Jhariya *et al.*, 2019a, 2019b).

Conclusion

Sustainability and sustainable development now became a key instrument for evaluation of any projects and developmental activities related to social, economic and environmental. The sustainability goals can be achieved through science & technology, good governance & management, and education and awareness of community in respect of resources and environment. Further the proper balance needs to be maintained between the society, nature and economy for moving towards sustainability with sustainable development approach with least environmental footprints.

References

Banerjee, A., Jhariya, M.K., Yadav, D.K. and Raj, A. 2020. *Environmental and Sustainable Development through Forestry and Other Resources*. Apple Academic Press Inc., CRC Press- a Tayler and Francis Group, US & Canada. ISBN:9781771888110. Pp. 1-400.

<https://doi.org/10.1201/9780429276026>.

FAO (2020). World's food systems rely on biodiversity. Food and Agriculture Organization, Rome. <http://www.fao.org/news/story/en/item/1263301/icode/>

Jhariya, M.K., Banerjee, A., Meena, R.S. and Yadav, D.K. 2019a. Sustainable agriculture, forest and environmental management. Springer Nature Singapore Pte Ltd., 152 Beach Road, #21-01/04 Gateway East, Singapore 189721, Singapore. eISBN: 978-981-13-6830-1, Hardcover ISBN: 978-981-13-6829-5. DOI: <https://doi.org/10.1007/978-981-13-6830-1>. Pp.606.

Jhariya, M.K., Yadav, D.K. and Banerjee, A. 2019b. *Agroforestry and Climate Change: Issues and Challenges*. Apple Academic Press Inc., CRC Press- a Tayler and Francis Group, US & Canada. ISBN:978-1-77188-790-8 (Hardcover), 978-0-42957-274-8 (E-book). Pp. 335. <https://doi.org/10.1201/9780429057274>.

Khan, N., Jhariya, M.K., Yadav, D.K. and Banerjee, A. 2020a. Herbaceous dynamics and CO₂ mitigation in an urban setup- A case study from Chhattisgarh, India. *Environmental Science and Pollution Research*, 27(3):2881-2897. <https://doi.org/10.1007/s11356-019-07182-8>.

Khan, N., Jhariya, M.K., Yadav, D.K. and Banerjee, A., 2020b. Structure, diversity and ecological function of shrub species in an urban setup of Sarguja, Chhattisgarh, India. *Environmental Science and Pollution Research*, 27(5):5418-5432.

- <https://doi.org/10.1007/s11356-019-07172-w>.
- Kongoli, F. 2016. Role of science and technology in sustainable development. In: Sustainable industrial processing summit and exhibition plenaries. Pp. 1-14.
- Raj, A., Jhariya, M.K., Yadav, D.K. and Banerjee, A. 2020. *Climate Change and Agroforestry Systems: Adaptation and Mitigation Strategies*. Apple Academic Press Inc., CRC Press- a Tayler and Francis Group, US & Canada. ISBN: 9781771888226. Pp. 1-383. <https://doi.org/10.1201/9780429286759>.
- Ulucak, Z.S., Cagrillkay, S., Ozcan, B. and Gedikli, A. 2020. Financial globalization and environmental degradation nexus: Evidence from emerging economies. *Resources Policy*, 67:101698. <https://doi.org/10.1016/j.resourpol.2020.101698>.
- UNEP(2015).The United Nations environment programme and the 2030 agenda.Global action for people and the planet.www.unep.org
- World Bank (2014). The report—The Little Green Data Book 2014 (<http://www.indiaenvironmentportal.org.in/reports-documents/little-green-data-book-2014>)—is based on World Development Indicators 2014 and its online database, which is an annual feature of the World Bank. The data book, released earlier this month, analyses wealth depletion of 136 countries.

Effects of earthquakes on environment

Rekha Agarwal

Government Science College
Old Robertson College, Estd.-1836
Jabalpur (MP)

Earthquakes can have disastrous effects on humans and on the environment. An earthquake is the result of trembling, rolling and vibration of the ground triggered by the sudden release of energy that is stored below the surface of the Earth. A scientific instrument called a seismometer is used by scientists to record, and measure strengths of earthquakes. The intensity or the size of an earthquake is measured by a number called the magnitude. Actually, earthquakes occur in everyday and everywhere and as a result, the estimate by scientists for each day is that more than thousands minor earthquakes happen without triggering any physical damage and mostly they are imperceptible. Earthquakes frequently occur in the following countries: China, Indonesia, Pakistan, Iran, United States, Japan, and the Philippines. In these regions there are a lot of earthquakes and also they have numerous volcanoes. There are three main causes of earthquakes: tectonic plate movement, human activities, and volcanic eruptions.

Earthquakes destroy property and cause death. On July 28, 1976, there was a 7.8 magnitude earthquake in the city of Tangshan (Rosenberg 1997). The strength of the earthquake was recorded by a scientific instrument called a seismometer, also known as a seismograph. It is an instrument that can detect and measure the ground motion from an earthquake (McNally 2007). At 0342 local time, the earthquake hit Tangshan and over a

million of people were sleeping. As a result, hundreds of thousands of people were killed and many people were reported missing and presumed dead. There were a lot of people were badly injured. Tangshan is located in Northeastern China (Ean area devastated by earthquakes. The earthquake was so strong that it triggered infrastructure collapse including houses, schools, shops, health clinics, roads, railway station, factories, and bridges. The people in Beijing also felt the tremors. A lot of people lost their lives because most their houses were completely destroyed. The city of Tangshan is being rebuilt nowadays by its citizens.

The main cause of earthquakes is tectonic plate movement. The crust of the earth consists of many pieces called tectonic plates. There are plates along the outer layer of the earth which are floating on the molten magma under the crust of the earth. (Ganguly 2008) The convection current in the molten magma drive the plates to move inside the earth. They move continuously until they pass through each other. When the two plates meet together, they start to push and rub each other but they are not moving. After a while, the pressure beneath builds up and keeps on rising. Once they cannot contain the pressure, it will be expelled. This sudden release of energy and the strength of the plates cause the ground shake and the two plates start to break. For example, on December 26, 2004, an earthquake hit the Sumatra,

Indonesia where the Indian and Burmese plates in India Ocean are broken and one plate is moved across the top of the other plate. (Magnitude 9.1-Off the West Coast of Northern Sumatra 2008) The region that breaks on the crust is known as a fault which usually can be seen on the surface of the earth. The point where earthquakes begin and break the plates underground is known as focus and above the focus, on the surface of the earth is called the epicenter. During plate movement, one plate gets submerged into the molten magma and another plate is moved across the top of it. This plate rises up due to the heat of molten magma. The plates keep on moving until they get stuck against each other. Most earthquakes take place on the edges of the plates where one plate is forced further into the earth crust while another plate is moved across the top of the submerged plate.

Another contributing factor to earthquakes is human activities. There are many human activities that cause an earthquake. Building skyscrapers is a good example that may cause an earthquake. Many engineers and scientists are concerned about the types of buildings in construction. Skyscraper Taipei 101 with the height of 508 meters which is the world's tallest building. According to the geologist Cheng Horng Ling (2005), from the National Taiwan Normal University, Taipei 101 may cause an earthquake because the 101-storey skyscraper is built the stress on an earthquake fault. An ancient earthquake fault may reopen as the stress from the buildings exerting on the ground increases. Besides that, the injection of fluids in the mountain or into the crust of the earth also triggers earthquakes. A long time ago, the main purpose of humans injecting fluid was that

the injection was the best way to dispose of toxic waste. For example, in the Rocky Mountains where there is a place for waste disposal. (Madrigal, A 2008) The injection of fluids into deep wells causes changing of the stress of the underground and the stress can generate an earthquake. Furthermore, the release of pressure when extracting oil and natural gas can also cause earthquake.

In addition, volcanic eruptions can also cause earthquakes. Normally, earthquakes are very active in areas of volcanic activity where they can either occur on their own or with the eruption. (Presnell 2002) Most of the time, the earthquakes triggered by the eruption of volcanoes are within ten to twenty miles around the volcanoes. In order to release the huge pressure that builds up by the molten magma underneath the earth crust, it always tries to look for an opening or an area that is fairly weak. (Ganguly 2008) Therefore, areas that have active volcanoes accompanied by volcanic activities are always prone to the earthquakes because the pressure builds up by the magma has surpassed the limit that earth crust can sustain. If a volcano eruption produces acidic lava then it can be predicted that there will an earthquake with the strongest magnitude. It is because acidic lava will solidify once it contacts the air and block the volcano's vents so that pressure cannot escape. As a result, pressure is developed inside and the resultant explosion can be destructive and destroying, producing an earthquake of significant magnitude.

Having looked at the causes of earthquakes, its main effects will be discussed in the following. The effects can be in terms of social, environmental and economic. An earthquake can bring great impacts to the society. It is an unbearable

scene as people die in the aftermath of earthquakes and leaving their loved ones to suffer from their death. Some of natural disasters like tsunamis and landslides can be triggered by earthquakes. Earthquakes can also have disastrous effect to the country's economy.

One of the biggest effects of earthquakes is the social impact on survivors. Earthquakes have short term impacts as well as long term impacts. The short term impacts can be seen in the aftermath of earthquakes. We can see thousands of people dying and many corpses. The 2008 earthquake in Sichuan, China, for instance, caused tens of thousands of deaths and hundreds thousands of people were injured. (Magnitude 7.9-Eastern Sichuan, China 2008.) A powerful earthquake can destroy buildings, factories, shops, roads, bridges and schools. These cause many people to become homeless. Furthermore, earthquakes can cause disruption to public services like transport systems and communication connections. Worst of all, survivors face a lack of drinking water because water pipes burst and water supplies are contaminated. In the cases of long term social impacts, thousands of children became orphans as their parents are killed in the earthquake. Most of the parents are depressed and the town lost a generation because their children were killed in schools that collapsed.

There are also environmental impacts. A tsunami, for instance, is produced by an earthquake. Tsunamis are tidal waves that are caused by the sudden movement of plates under the sea floor during an underwater earthquake. This wave can move swiftly a long way across the ocean. When a large scale of tsunami hits the seashore area, it can trigger enormous erosion as well as destroy buildings in its

path. Worst of all, people will also be washed away by the tsunami. For example, on December 26, 2004, a tsunami hit some nations around the Indian Ocean and caused hundreds of thousands of deaths. Earthquakes can cause landslides. It is very dangerous especially for buildings in unstable area on hillsides or mountains where soft soils can be liquefied by the tremors of earthquakes. During an earthquake, buildings can fall down hills with soil and bury people under the soil. People will be buried alive. In addition, aftershocks are also effects of earthquakes. Aftershocks are small tremors which disperse it to other places and other people can feel it after the main shocks of an earthquake. For instance, in Penang, Malaysia, there are no earthquakes, but when an earthquake happened in Sumatra it was so great that even Malaysians living. Apart from social and environmental impacts, earthquakes also have negative effects on a nation's economy. Governments have to be responsible for the damage caused by earthquakes. As we can see, earthquakes cause infrastructures to collapse, reservoirs dams, shops, and hospitals are devastated after an earthquake. Governments have to spend sizeable amounts of money to rebuild the place. Earthquakes also cause spending of the capital to distribute food and medicine to victims. Markets in particular may be disrupted and this causes uneasy trade. Furthermore, investors whose money is in that particular area for development may decide to withdraw. Once the investors withdraw the investment in the particular country, it will cause loss of job opportunities as well as the country's income diminishing and an unstable of economy.

The earthquake-related impacts on the environment can be categorized into three sections. (1) Conflagrations caused by the earthquake: There is an estimate regarding how much of what kinds of chemical substances were burnt but unfortunately there was no investigation conducted after the conflagrations. (2) Demolition work-related: The problem with scattering asbestos used in the demolished constructions attracted a certain level of attention but the problem of concrete particles, to which residents in the disaster-affected areas were exposed to as much as the workers were, was not grasped. (3) Disposal of earthquake waste: Many residents in the areas near disposal centers, especially the weak such as the elderly and children, were greatly influenced. The situation was, however, not sufficiently grasped.

According to research conducted half a year after the earthquake in the disaster-hit areas, 25% of responders answered that their health was influenced after the disaster, 70% of which said it was an impact on the respiratory organs. Such respiratory disorders were most likely caused by exposure to dusts from the works of buildings demolition and exhaust gas from heavy machinery, trucks and other vehicles for construction and conveyance, and toxic gas from the conflagrations and open incineration of waste.

After the great earthquake, a huge amount of waste of about 20 million tons was emitted in only just the 20 municipalities designated as "severely damaged" by the Disaster Relief Act. It was about eight times as much as the entire amount of the general waste emitted in Hyogo prefecture in the year previous to the earthquake. The whole amount of destroyed objects by the

earthquake was treated as waste, with little consideration given to recycling.

About 80% of the earthquake waste, in terms of weight, was incombustible garbage, of which 70-80% was concrete and mortar, and the rest was steel frames and aluminum sashes. Combustibles, which occupied about 20%, consisted of wood, paper and plastics.

Ten places were designated as disposal centers for earthquake waste in Hyogo prefecture. Though temporarily, some waste was incinerated in open fields and in one case, the longest period, this continued for three months. The gas from the incineration obviously caused allergies and asthma attacks for the weak such as infants and the elderly who were exposed to it.

Air pollution was caused by the fact that there was such a huge amount of earthquake waste consisting of objects unsafe to the environment. One cause of the increase in the waste was the fact that even restorable buildings were demolished at once with public aid.

It is well-known nowadays that dioxins are generated during the process of waste incineration. It is not possible to find out exactly how much of the earthquake waste was incinerated, but it is said that the municipal governments disposed of 2.78 million tons of earthquake waste, of which 2.09 million tons was disposed of by incineration. The incinerated ash is believed to have contained a high concentration of dioxins and heavy metals. Miyata Hideaki, a professor at Setsunan University reported in his book about dioxin contamination (Yoku Wakaru Daiokishin Osen), 1998, "With the amount emitted into the air given consideration, the amount of dioxins generated in the open incineration equals the amount

generated by the 1976 agrochemical plant explosion in Seveso, Italy."

Also according to the result of research on the seafloor about two kilometers off shore between Nagata-ward and Suma-ward, Kobe, for three years from 1997, conducted by SAKAI Shinichi, director at the Research Center for Material Cycles and Waste Management, the National Institute for Environmental Studies, the concentration which had been around 10 picogram per 1 gram suddenly increased to 38 picogram -- nearly 4 times. Also the mud containing dioxin was traced to have been carried down by two rivers which run through Nagata-ward and Suma-ward, where conflagration occurred. It is concluded that dioxins generated in the quake-hit areas flew down through the rivers and accumulated on the seafloor.

The total amount of waste directly buried in the ground was 0.67 million ton, combining 0.45 million ton disposed by municipalities and 0.22 million ton by the consigned private sector.

In a landfill site in the mountains in Kobe city, Fusehata site, all sorts of earthquake waste including toxic chemical substances were piled up mountain-high and a temporarily established incinerator was in a full-operation. A great amount of asbestos was left in bags. There was no environment-protection such as rubber sheeting in the Fusehata site. In July, 1999, the fifth year after the earthquake, an official in charge said "the asbestos was buried there just as it was"

The disposal and leaving of the earthquake waste for stopgap is causing serious secondary contamination.

In conclusion, earthquakes are hard to predict and can happen any time. Tectonics plate movement, human activities and volcanic eruptions are 3 of

the causes of earthquakes, whose effects can be felt socially, environmentally, and economically. As we can see, prevention of earthquakes is absolutely impossible, so, suitable action to reduce injury and death is of uttermost importance. Some safety action should take place, such as evacuation and safety build structures to resist earthquakes. Some countries, such as the United States and Japan carried out research about public buildings designed to resist earthquakes. (Moleworth 2008) The results are that the whole building will move to and fro without trembling. It is very important to have this facility in earthquakes zones as damage and lives are at risk.

References

- Bignerds. 2008. Earthquake.
<http://www.bignerds.com/essays/Earthquake/1237.html> (accessed October 6, 2008)
- Earthquake. n.d.
<http://www.bbc.co.uk/schools/gcsebitesize/geography/platetectonics/earthquakesrev3.shtml> (accessed October 13, 2008)
- Effects of earthquakes. n.d.
<http://www.olympus.net/personal/gofamily/quake/effects.html> (accessed October 21, 2008)
- Ford, R. 2004. Glossary.
<http://resweb.llu.edu/rford/docs/VGD/GSLVT/gslglossary.html> (accessed October 21, 2008)
- Ganguly, P. 2008. What causes earthquakes?
<http://www.buzzle.com/articles/what-causes-earthquake.html> (accessed October 17, 2008)
- Madrigal, A. 2008. Top 5 ways to cause a man-made earthquake.

- <http://blog.wired.com/wiredscience/2008/06/top-5-ways-that.html> (accessed October 29, 2008)
Magnitude 7.9-Eastern Sichuan, China. 2008.
- <http://earthquake.usgs.gov/eqcenter/recenteqsww/Quakes/us2008ryan.php> (accessed October 13, 2008)
Magnitude 9.1-Off the West Coast of Northern Sumatra. 2008
- <http://earthquake.usgs.gov/eqcenter/eqinthenews/2004/usslav/> (accessed October 13, 2008)
- McNally, K. 2007. Earthquake.
http://www.nasa.gov/worldbook/earthquake_worldbook.html (accessed October 13, 2008)
- Molesworth, C. 2008. Pacific builder and engineer.
<http://www.acppubs.com/blog/1210000521/post/260034826.html> (accessed October 27, 2008)
- Presnell, W. 2002. What causes earthquakes?
http://www.essortment.com/hobbies/cause_searthquak_tsjl.htm (accessed October 21, 2008)
- Ravillious, K. 2008. Skyscraper that may cause earthquakes
<http://www.guardian.co.uk/environment/2005/dec/02/naturaldisasters.climatechange> (accessed October 6, 2008)
- Rosenberg, J. n.d. Tangshan: The deadliest earthquake.
<http://history1900s.about.com/od/horribledisasters/a/tangshan.htm> (accessed October 21, 2008)
- See, B and S. C. Looi. 2008. Tremors felt in Penang.
<http://thestar.com.my/news/story.asp?file=/2008/2/20/nation/20080220191502&sec=nation> (accessed October 13, 2008)
- The Free Dictionary. n.d.
<http://www.thefreedictionary.com/aftershock> (accessed October 30, 2008)
- What are the effects of earthquake? n.d.
http://www.usgs.gov/faq/list_faq_by_category/get_answer.asp?id=197 (accessed October 30, 2008)
- Why do earthquake happen? n.d.
<http://www.geo.mtu.edu/UPSeis/why.html> (accessed October 17, 2008)



Published by:



Tropical Forest Research Institute

(Indian Council of Forestry Research & Education)

(An autonomous council under Ministry of Environment, Forests and Climate Change)

P.O. RFRC, Mandla Road

Jabalpur – 482021, M.P. India

Phone: 91-761-2840484

Fax: 91-761-2840484

E-mail: vansangyan_tfri@icfre.org, vansangyan@gmail.com

Visit us at: <http://tfri.icfre.org> or <http://tfri.icfre.org>